



Power Strip

CLEVER

USER GUIDE

WELCOME!

In this guide you'll find all the information you need to get the most out of your SPC Smart Power Strip.

CREATE AN SPC ACCOUNT

A ton of free advantages just a click away.

Before continuing reading this guide, we recommend visiting **www.spc-universe.com**, **CREATE AN SPC ACCOUNT AND REGISTER YOUR PRODUCT.**

That way, you'll join the SPC universe: an exclusive club for our clients with great discounts, such as promotions to improve or update your SPC system.

Furthermore, with this account you'll have **free access to all of SPC's services**, like apps for tablets and smartphones and our technical support section.

That's SPC. A universe in technology.

SPC IoT: “An app for your Smart Home products”

At SPC we believe in practicality and convenience, which is why we've worked hard to create a new app you can control ALL of your **SPC IoT** Smart Home devices from.

INTERACTION BETWEEN DIFFERENT DEVICES AND MORE FUNCTIONALITY

Via our SPC IoT app you'll be able to get your SPC IoT devices to interact creating conditionals.

Do you want your living room light to turn on when your camera detects movement?

Do you want your air conditioning to turn on when the temperature goes up in your room?

Do you want to change the TV channel by speaking to Alexa or Google home?

You'll be able to find out how to do this and a lot more in SPC IoT app's detailed manual.

Get access to technical support on our website **www.spc-universe.com** and download it!

One app for all SPC IOT products



© 2018 Smart Products Connection S.A.

BOX CONTENTS

- SPC Smart Power Strip
- User Manual

CHARACTERISTICS and DESCRIPTION OF THE DEVICE

Smart power strip with outlets and USB ports Wi-Fi that can be:

- **Remotely switched on.**
- **Is programmable.**
- **Used as a timer.**

All controllable by an app.

Available models:

- **SKU. 6202B** (Length 180 cm, Max Power 2400W, 3 AC Outputs, 4 USB ports -5V DC)

LOCALIZACIÓN DE CONTROLES

EN

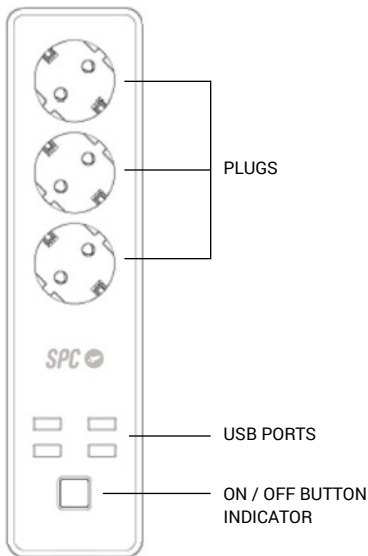

USE OF THE POWER STRIP

PLUGGING IN THE POWER STRIP

Plug your SPC Clever Power Strip into any outlet in your home like any other plug.

DOWNLOAD THE SPC IOT APP FROM THE APPLE STORE OR PLAY STORE

Look in the market for the **SPC IoT** app, download and install it. Or if you prefer, scan the QR code through which you'll access our website where you'll find the links to your

market. Download and install the app.



CREATE AN ACCOUNT

The first time you open the **SPC IOT** app, you'll have to create an account.

EN

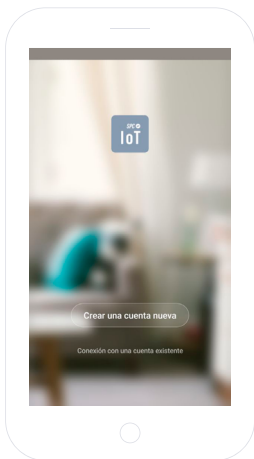

- Enter your geographical region and telephone number or e-mail address.
- You'll receive a security code by SMS or email (depending on the data you've provided). Enter it in the corresponding box.
- Enter a password that's between 6 and 20 characters which contains numbers and characters.

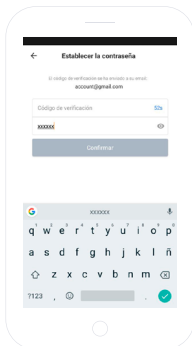
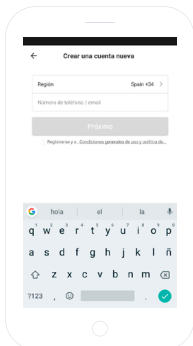

CREATE YOUR FAMILY AND THE ROOMS IN YOUR HOME

EN

- Assign your family a name.
- Select the rooms you want to be visible.

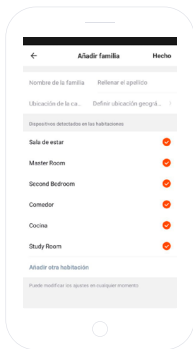
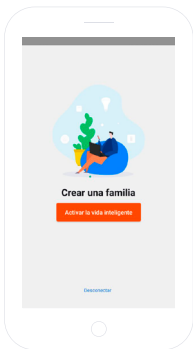

ADD A DEVICE

- Chose the type of product you want to add, in this case, **“Plugs”**.

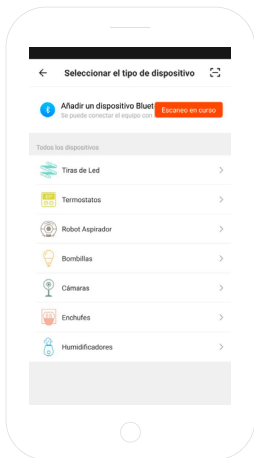

SYNC YOUR DEVICE WITH THE SPC IOT APP

- In order for your power strip to enter search mode: unplug and then plug it in again. If the device does not enter search mode, hold the on/off button for 5 seconds. The LED indicator will start to flash quickly (twice a second).
- Selection the **"Confirm"** option in the app.

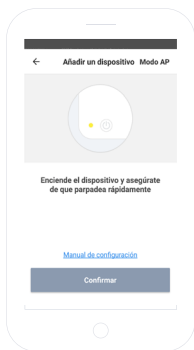

- Enter the WiFi password for your house or select the network if you're not connected.
- You'll see a timer showing a percentage, after a few seconds your power strip will be added correctly. If you are unable to synchronise your strip repeat the process again.

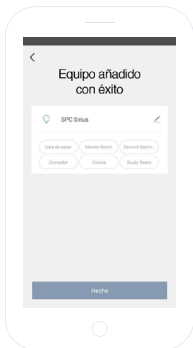
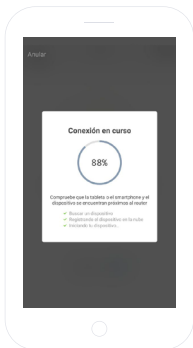

Now you'll be able to access the controls and functions for the power strip, even when you're away from home.

EN

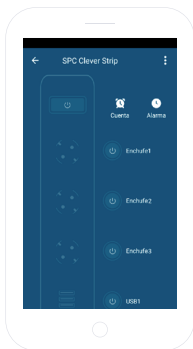

CONTROL PANEL

The features of the SPC Clever Power Strip are shown below:

- **Power:** Switch the whole strip on and off.
- **Timer:** Countdown timer for turning off the various outlets and ports individually.
- **Alarm:** Program a timer for switching the individual outlets and ports on / off.
- **Plug / USB:** Manual power on / off for each individual outlet or port.

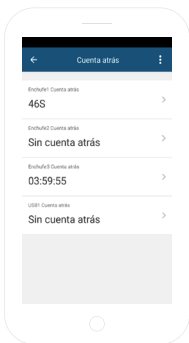
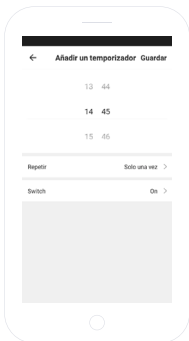

SHARE THE DEVICE

If you want to share one of the **SPC IoT** devices with a family member:

Go to the device you want to share's control panel from the added devices panel.

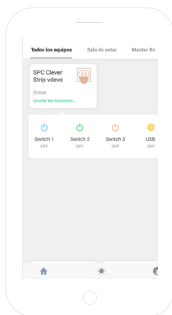

Select the option more settings and the options in the upper right hand corner of the control panel.

EN

Select the function **“Share device”**.

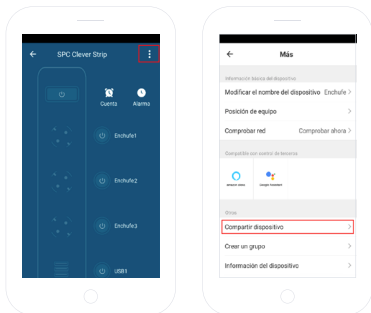



Enter the telephone number or email account of the person you want to share the device with.

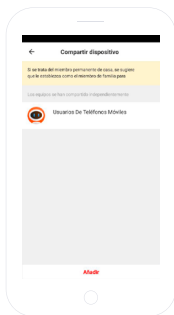
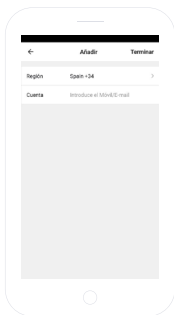

MINIMUM REQUIREMENTS:

To use the service from a smartphone, tablet or iPad, the minimum requirements are as follows:

- Android 4.0 or higher.
- iOS 8.0 or higher.

Copyright © 2018 SPC

www.spc-universe.com

The information contained in this manual cannot be transferred, reproduced or distributed under any circumstances without written permission from SPC.

TRADEMARKS

SPC is a registered trademark of **Smart Products Connection S.A.**

NOTE: SPC reserves the right to modify the information in this manual at any time, which, has been carefully designed, although all of the information and recommendations provided in it do not constitute any guarantee.



spc-universe.com

