



Smartwatch

SMARTEE POP

GUÍA TÉCNICA / TECHNIQUE GUIDE / GUIA TÉCNICO

¡ BIENVENIDO !

En esta guía encontrarás toda la información para sacar el máximo partido a tu SPC Smartee Pop.

CREA UNA CUENTA SPC

Un montón de ventajas gratis a un click.

Antes de continuar leyendo esta guía, te recomendamos que visites **www.spc-universe.com**, CREES UNA CUENTA SPC Y REGISTRES TU PRODUCTO.

Así, entrarás en el universo SPC: un club exclusivo para nuestros clientes con importantes descuentos, así como promociones para mejorar o renovar tu equipo SPC.

Además, con esta cuenta podrás **acceder gratis a todos los servicios de SPC**, como apps para tablets y smartphones y a nuestro apartado de soporte técnico.

Esto es SPC. A universe in technology.

CONTENIDO DE LA CAJA

- Smartee Pop
- Base de carga
- Cable USB
- Manual de usuario
- Hoja de garantía

CARACTERÍSTICAS

- Notificaciones, contactos, llamadas de teléfono, monitor de sueño, podómetro, cardiómetro, calendario, metereología, aviso sedentario, recordatorio, multideporte, asistente de voz, cámara y música remota.
- Micrófono y altavoz.
- Aplicacion "Smartee" para Android e iOS.

LOCALIZACIÓN DE CONTROLES

ES

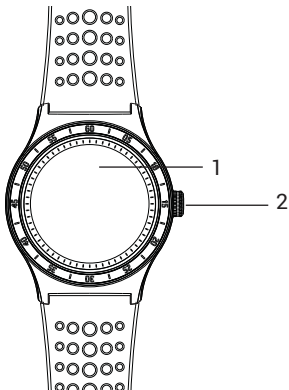

1. Pantalla

2. Botón encendido/apagado

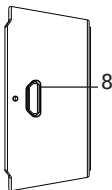
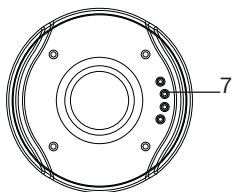
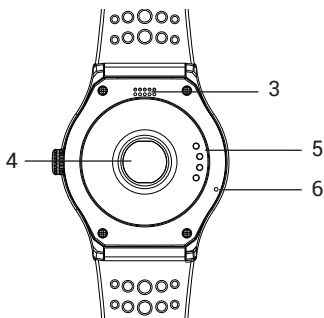

3. Altavoz

4. Pulsómetro

5. Pines de conexión

6. Micrófono

7. Pines de conexión

8. Entrada mini USB

USO DEL RELOJ

ENCENDIDO Y APAGADO

Mantén pulsado el botón de encendido durante tres segundos para encender el reloj. Para apagarlo procede del mismo modo.

NAVEGANDO POR LOS MENÚS

Con la pantalla encendida, podrás navegar entre los diferentes menús realizando los siguientes gestos: Pulsación de pantalla, deslizamiento vertical y horizontal.



Con los gestos mencionados podrás navegar por los menús horizontales y verticales. Desde la pantalla principal podrás acceder a los menús verticales inferiores y superiores girando la rueda de navegación del reloj. Para confirmar pulsa éste mismo botón.



CARGA DEL DISPOSITIVO

Para cargar el reloj, sitúalo sobre la base de carga con los polos de conexión en contacto con el reloj en la posición correcta. Conecta un extremo del cable USB a la base de carga y el otro extremo a un ordenador o fuente de alimentación.

PANTALLA PRINCIPAL



Desde la pantalla principal podrás acceder mediante los botones o mediante el panel táctil a todos los menús disponibles en tu dispositivo.

MENÚ VERTICAL

Deslizando de arriba a abajo navegarás por el menu vertical superior.



Ajusta el nivel de brillo de la pantalla.



Configura el reloj con/sin sonido, o solo vibración



Apaga Bluetooth y muestra perfiles Bluetooth conectados



Enciende/Apaga el sensor de movimiento



Busca el dispositivo móvil vinculado al Smartwatch

MODOS DEL SMARTWATCH

El reloj posee varios modos o perfiles. Cada uno con las siguientes características:

Icono	Modo	Sonido	Vibración	Bluetooth	GPS	Brillo
	General	Sí	No	Sí	No	Medio
	Reunión	No	Sí	Sí	No	Medio
	Avión	Sí	No	No	No	Medio
	Deportivo	Sí	No	Sí	Sí	Alto
	Ahorro	No	No	No	No	Bajo



Visualiza la información
metereológica



Muestra el calendario

Deslizando de abajo a arriba o girando la rueda hacia arriba, navegarás por el menu vertical inferior. Podrás ver tu actividad diaria en diferentes pantallas:



Muestra información de tu
actividad actual. Por defecto
aparecerá "Caminar"



Muestra información de sueño de la última noche. Desde ésta pantalla podrás visualizar ésta información en detalle. Pulsando sobre las tres barras horizontales entrarás en la configuración del modo sueño, pudiendo configurar hora de inicio y fin, y activarlo o desactivarlo.

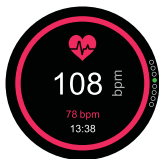

Muestra información de tu pulso en la última toma que se realice. Si deseas realizar otra toma de datos pulsa en el centro de la pantalla. Tras varios segundos el reloj mostrará tu pulso actual.



Muestra próximos recordatorios. Podrás activarlos y desactivarlos. Establece las alarmas desde la aplicación Smartee.

ACTIVIDAD DIARIA

Desde la pantalla principal, deslizando en la pantalla táctil de abajo a arriba, o girando la rueda hacia arriba aparecerá un menú que se despliega de la siguiente forma:

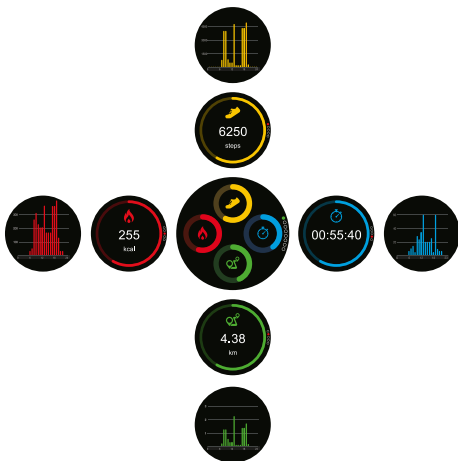

METAS DIARIAS

Establece diferentes metas para cada dato obtenido por el reloj. Para ello pulsa el botón editar. Se listarán todos los parámetros a los que les puedes poner una meta.

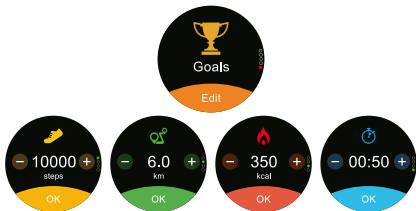





Pulsando en los simbolos +/- ajustarás la cifra, pulsa OK para establecer ésa meta.

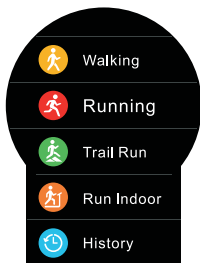

REALIZAR UN DEPORTE

Gracias a tu Smartee Pop, podrás parametrizar un deporte entre los 5 que trae por defecto tu Smartwatch. Lo primero que debes hacer es seleccionarlo. Para acceder al listado de deportes, pulsa el botón deporte. Accederás a la lista de deportes a realizar:



-  Caminar
-  Correr
-  Senderismo
-  Correr en cinta

Una vez seleccionado, podrás establecer metas para el deporte. Ajusta los parámetros de distancia, calorías, tiempo total y ritmo (min/km)



Durante la actividad, cuando cumplas una meta recibirás una alerta en el reloj.



Si no quieres establecer una meta, activa el modo libre:



Antes de iniciar el deporte, acepta o rechaza el capturar el ritmo cardiaco.

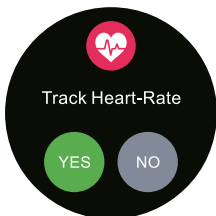

Durante la actividad, podrás consultar en vivo los siguientes datos:

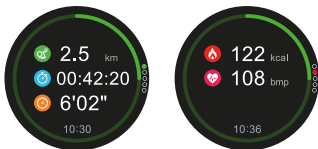

En caso de tener el pulsómetro activado podrás ver en qué franja cardiaca estás en ese momento.

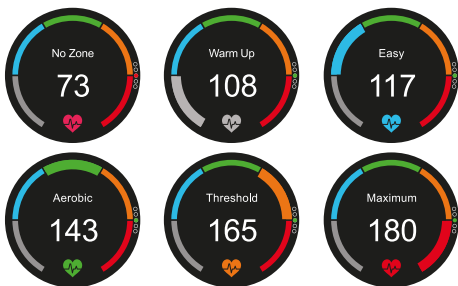

En la última pantalla, podrás terminar una actividad o pausarla para continuarla más tarde.



Una vez finalizado el deporte, verás todos los parámetros que ha capturado el reloj. Podrás elegir si guardar éste deporte o eliminarlo del reloj.

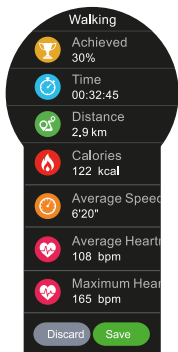

En caso de guardarlo podrás verlo más tarde en tu Smartphone gracias a la aplicación Smartee y en el reloj, en la sección Historial, dentro del listado de deportes.

ACCESOS DIRECTOS

En el menú vertical del Smartphone, encontrarás accesos rápidos a todas las demás funciones del reloj. Para poder emplear algunas tendrás que tener el Smartwatch conectado a tu Smartphone.



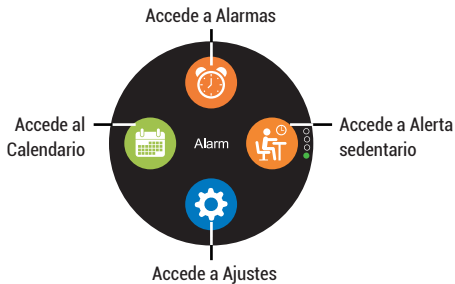

AJUSTES

En el menú ajustes podrás configurar los siguientes parámetros de tu reloj. Alguno de éstos parámetros se pueden modificar desde la aplicación Smartee:

- Perfil: Ajusta datos de tu perfil.
- Bluetooth: Enciende/Apaga la conexión Bluetooth.
- Monitor de sueño: Ajusta horas de inicio/fin del modo sueño.
- Hora y fecha: Ajusta el formato de hora y fecha.
- Unidad: Elige en qué medida aparecerán los datos en el reloj.
- Movimiento: Activa/Desactiva el sensor de movimiento para el gesto de muñeca.
- Efecto de sonido: Ajusta parámetros de sonido para las diferentes alertas.
- Visualizar: Ajusta parámetros de la pantalla.
- Ver información: Muestra información de tu dispositivo.

- Idioma: Ajusta el idioma del dispositivo.
- Batería: Muestra el porcentaje de carga de la batería.
- Restablecer: Restablece el dispositivo de fábrica.

APP SMARTEE

Para descargarte la aplicación compatible con tu SPC Smartee Pop, busca en el PlayStore para Android y AppStore para iOS "Smartee".

En la pantalla principal, si ya posees una cuenta SPC podrás iniciar sesión. En caso de no ser usuario, podrás crear uno nuevo registrandote.

CONEXIÓN EN ANDROID

De manera automática, tras iniciar sesión, Smartee requerirá permisos a Android para poder realizar todas las funciones correctamente. Si deseas disfrutar de todas las funciones de tu reloj deberás aceptar todos.

Para conectar en Android tu Smartwatch, en Smartee, ve a Dispositivos. Tendrás que tener el Bluetooth del teléfono y el del Smartwatch activado. Para vincularlo tendrás tres

métodos: escaneando el número de serie, introducirlo a mano o buscarlo en el listado de dispositivos compatibles, dentro de la sección “¿Necesitas ayuda?”. El dispositivo debería aparecer así:

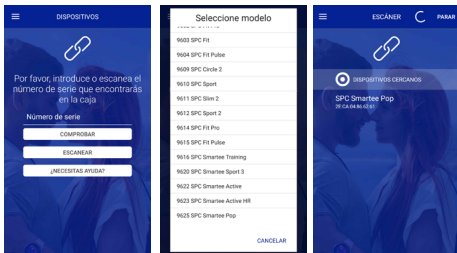

Dependiendo de la versión de Android y modelo de móvil puede que pida algún permiso extra, como en la imagen inferior.



Aceptando ésto no debería haber problemas de conexión entre ambos dispositivos.

Una vez conectado la sección dispositivos debería verse tal que así:



En ésta sección podrás configurar parámetros que, a su vez, también se pueden configurar desde el propio reloj.

En ésta pantalla principal verás los datos de actividad del día. Para refrescarlos desliza el dedo de arriba a abajo.



CONEXIÓN EN iOS

Después de iniciar sesión con tu usuario de SPC, podrás acceder a la sección dispositivos para vincular tu Smartwatch.

Para conectar en iOS tu Smartwatch, en Smartee, ve a Dispositivos. Tendrás que tener el Bluetooth del teléfono y el del Smartwatch activado. Para vincularlo tendrás tres métodos: escaneando el número de serie, introducirlo a mano o buscarlo en el listado de dispositivos compatibles, dentro de la sección “¿Necesitas ayuda?”. El dispositivo debería aparecer así:

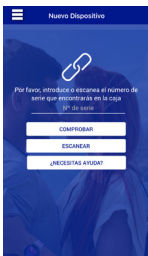

En iOS, para poder disfrutar de todas las funciones de tu Smartwatch, tendrás que conectar desde ajustes Bluetooth, el segundo perfil Bluetooth de tu Smartwatch.

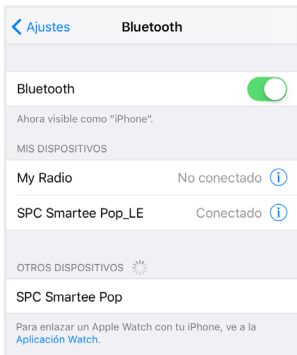
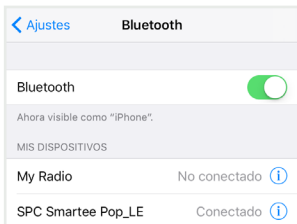



Con los dos perfiles Bluetooth conectados, en tu Smartwatch aparecerá el icono Bluetooth de la siguiente manera: 

Funciones como llamadas, contactos, búsqueda de dispositivo, solo están disponibles con los dos perfiles Bluetooth conectados.

Para cualquier duda en la sección soporte encontrarás una guía de uso de la aplicación Smartee. Podrás ver los diferentes apartados que componen la app y sus funciones.

Copyright © 2017 SPC
www.spc-universe.com

La información que contiene esta guía no podrá en ningún caso transmitirse, reproducirse o difundirse de forma alguna sin la autorización por escrito de SPC.

MARCAS COMERCIALES

SPC es una marca registrada de **Smart Products Connection S.A.**

NOTA: SPC se reserva el derecho de modificar en cualquier momento la información de esta guía, la cual se ha elaborado con el mayor cuidado, si bien toda la información y recomendaciones que aquí constan no constituyen garantía alguna.

WELCOME !

This guide includes all the information to make the most out of your Smartee Pop.

EN

GET AN SPC ACCOUNT

Free advantages just one click away.

Before going on reading this manual, we strongly recommend you visiting **www.spc-universe.com**, SO YOU CAN CREATE AN SPC ACCOUNT AND REGISTER YOUR PRODUCT.

By doing this, you will be able to get into SPC universe: an exclusive club where our clients can get incredible offers and discounts and also upgrade or renew their products.

Moreover, **having an account means free access to SPC services**: tablet and smartphone apps, technical support...

This is SPC. A universe in technology.

BOX CONTENTS

- Smartee Pop
- Charger base
- USB cable
- User manual
- Warranty sheet

FEATURES

- Notifications, contacts, phonecalls, sleep monitor, pedometer, heart rate monitor, calendar, weather, sedentary alert, reminder, multisport, voice assistant, remote camera and music.
- Microphone and speaker.
- “Smartee” app for Android and iOS

CONTROLS LOCALIZATION

EN

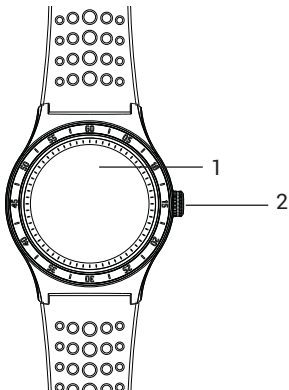

1. Screen

2. Turn ON/OFF button

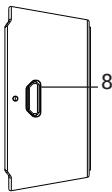
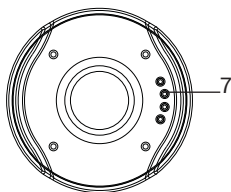
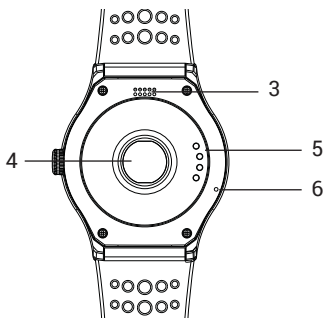

- 3. Speaker
- 4. Heart rate sensor
- 5. Connection pins

- 6. Microphone
- 7. Connection pins
- 8. Micro USB input

USE OF WATCH

TURN ON/OFF

Keep pressed the turn on/off button during 3 seconds to turn the smartwatch on. To switch it off, proceed in the same way.

BROWSING BETWEEN MENUS

With the screen on, you can browse between the different menus doing the next movements: screen tap, vertical and horizontal slide.



With the movements mentioned you can browse between the horizontal and vertical menus. From the main screen you can browse into the inferior and upper menus using the wheel on the side of the watch. To confirm your choice, press this same button.



BATTERY RECHARGE

To charge the Smartwatch, place it on the battery charger base, with the poles making contact with the watch in correct position. Plug one end of the USB cable to the battery charger base, and the other one to a computer or a power supplier.

MAIN SCREEN



From the main screen you will be able to access using the buttons or the touch panel, to all the available menus in your device.

VERTICAL MENU

Sliding from up to down, you will browse in the vertical upper menu.

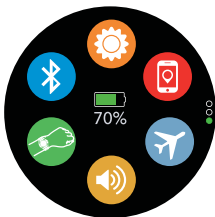

Set the brightness of the screen



Set the watch with/without sound, or just vibration



Turns off the Bluetooth and shows the Bluetooth profiles connected







Turn ON/OFF the movement sensor



Search the device linked to the Smartwatch

SMARTWATCH PROFILES

The smartwatch has several profiles. Each one with the following features:

Icon	Mode	Sound	Vibration	Bluetooth	GPS	Brightness
	General	Yes	No	Yes	No	Mid
	Meeting	No	Yes	Yes	No	Mid
	Plane	Yes	No	No	No	Mid
	Sport	Yes	No	Yes	Yes	High
	Low-power	No	No	No	No	Low



Shows the meteorological information



Shows the calendar

Sliding from down to up or spinning the wheel, you will browse in the lower vertical menu. You will be able to see your daily activity information in different screen:



Shows your current activity information. It will show "Walking" by default.



Shows the sleep information of the last night. From this screen you can see the information in detail. Pressing in the three horizontal rods you will be able to set the sleep mode, setting the ending and finishing time, and turning it OFF/ON

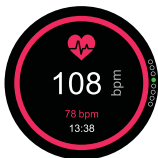

Shows your last cardio information taken. If you wish to make another capture press on the center of the screen. Few seconds later the watch will show your current pulse.



Shows the next reminders. You can turn them ON/OFF. Set the reminders in Smartee app.

DIALY ACTIVITY

From the main screen, sliding in the touch panel from bottom to top, or spinning the wheel upwards, a menu will show up. It is displayed as here follows:

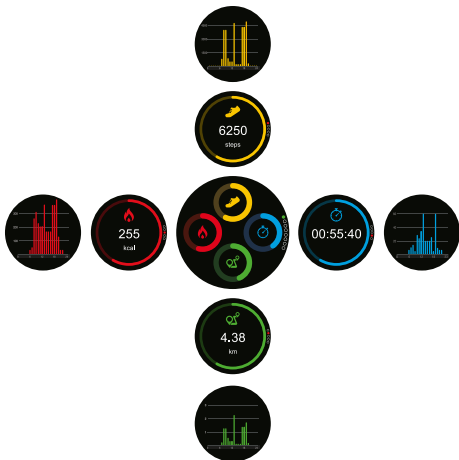

DIALY GOALS

Set the different goals for each data obtained by the Smartwatch. For this, press the button "Edit". All the parameters where you can set a goal will be listed.

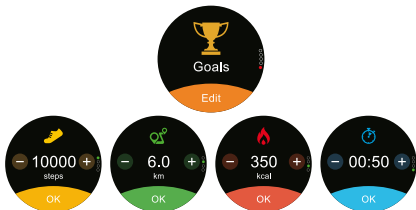

Pressing on the symbols +/- you will set the number, press OK to set that goal.



PLAY A SPORT

Thanks to your Smartee Pop, you will be able to parameterize an activity between the 5 sports that your Smartwatch has by default. Firstly you have to choose it. To go to the sport list, press the Sport button. The sports will show as here follows:

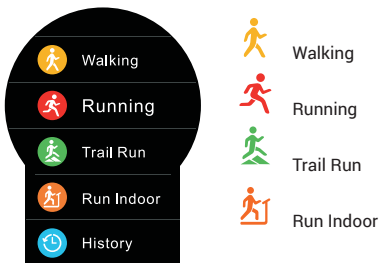

Once you have chosen, you can set a goal for the sport. Adjust the parameters of distance, calories, total time and the average (min/km)



During the activity, when you complete a goal, you will receive an alert in the Smartwatch.



If you don't want to set a goal, you can choose the "Free Style" mode:



Before starting the sport, accept or decline to capture the heart rate.

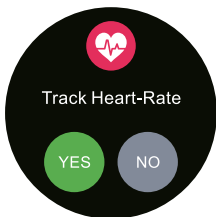

During the activity, you can check the following info on live:

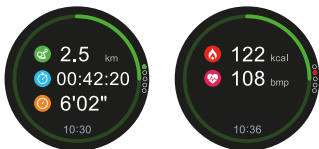

In case that you have activated the pulsometer, you can see in which threshold you are.

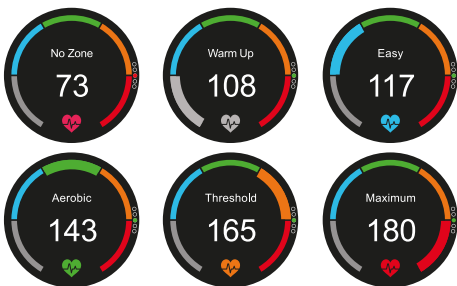

In the last screen you can finish the activity or pause it to continue later.



When you finish the sport, you will see all the parameters captured with the watch. You can choose between saving this activity or removing it from the Smartwatch.

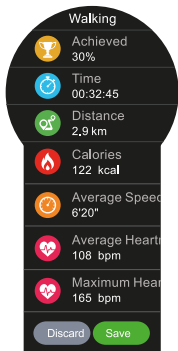

If you decide to save it, you can see this info in the Smartphone thanks to Smartee app and in the Smartwatch in the History, listed on the sport list.

SHORTCUTS

In the vertical menu of the Smartphone, you will find the shortcuts to all the rest functions of the watch. Some of these functions are available only if you have the Smartwatch connected to your Smartphone.



Turn ON the voice assistant

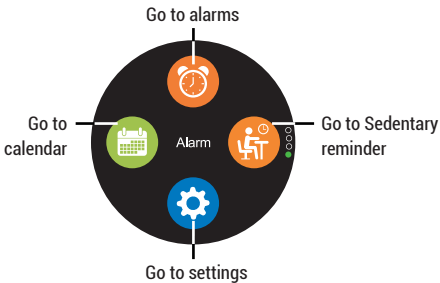
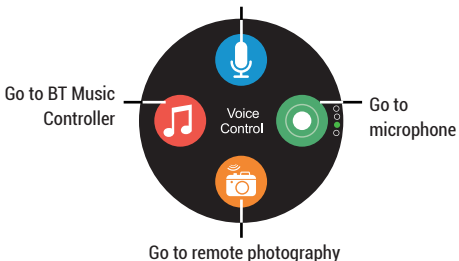

SETTINGS

In the settings menu you can set up the following parameters of the Smartwatch. Some of them can be modified through the Smartee app:

- Profile: Set the profile info.
- Bluetooth: Turn Bluetooth ON/OFF.
- Sleep Monitor: Set the beginning/ending time for the sleep monitor.
- Time and Date: Set the format of time and date.
- Units: Choose in which measure will appear the info of the Smartwatch.
- Activate on wrist flisk: Turn ON/OFF the movement sensor for the wrist gesture.
- Sound: Set the sound parameter for each alert.
- Display: Set the screen parameters.
- Watch info: Shows device's info.

- **Language:** Set the language for the device.
- **Battery info:** Shows the battery percentage charged.
- **Restore to factory:** Restore the device with the default settings.

SMARTEE APP

To download the application compatible with your SPC Smartee Pop, search in the PlayStore for Android and AppStore for iOS “Smartee”.

In the main screen, if you already have an SPC account, you can log in. If you aren't a SPC user, you can create a new account pressing on register.

CONNECTION ON ANDROID

Automatically, once you are logged in, Smartee will ask for permissions to Android in order to have all the functions available and workable. If you wish to have all the functions working, you will have to accept all of them.

To connect in Android your Smartwatch, in Smartee, go to Devices. You have to turn ON your Bluetooth, and have the Bluetooth of your Smartee Pop ON too. To link the device

you have three different ways: scanning the serial number, introduce it by hand or search the device from the list of compatible devices, inside the “Do you need help?” section. The device will appear like this:

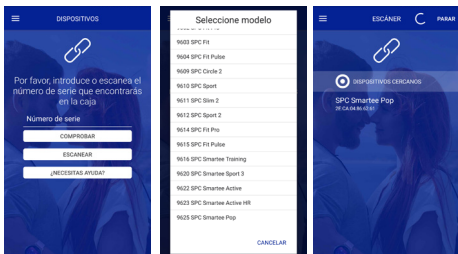

Depending on the Android version installed, and the mobile model, maybe it will ask some extra permission, like in the image below:



Accepting this, there shouldn't be any connection problems between both devices.

Once you have connected the device, the Device section must be displayed like this:



In this section you will be able to set parameters that, at the same time, can be set through the Smartwatch by itself.

On this main screen you will see the diary activity info. To refresh them slide on the screen from top the bottom.



CONNECTION ON iOS

Once you are logged in with your SPC user, you will be able to go to the Devices section, to link the Smartphone to the Smartee Pop.

In iOS, to connect your Smartwatch in Smartee, go to Devices. You will have to turn ON the Bluetooth in the iPhone and the Smartwatch. To link it, there are three different way: scanning the Serial Number, introducing it by hand or searching for it in the model list, inside the “Do you need help?” section. The device should appear like this:

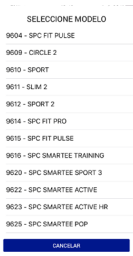

In iOS, to enjoy of all the functions of your Smartwatch, you will have to connect it from the Bluetooth settings on your iPhone, there you will have to select the second Bluetooth profile.

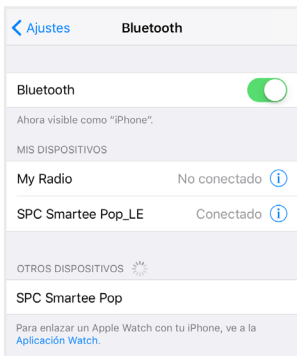
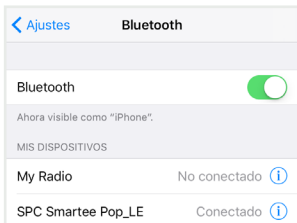



With both profiles connected to your iPhone, the Bluetooth icon will show up like this: 

Functions like phone callings, contacts, device research, are only available if you have both profiles connected.

For any doubt, in the support section of the Smartee app, you will find a guide of use for the entire Smartee app. You will be able to see the different sections and functions available in Smartee app.

Copyright © 2017 SPC
www.spc-universe.com

EN

The information that this guide contains cannot be transmitted, played or distributed in any case without the written authorization of SPC.

COMERCIAL BRANDNAMES

SPC is a registered brandname of **Smart Products Connection S.A.**

NOTE: SPC reserves the right to modify at any time the information in this guide, which was developed with the greatest care, although all the information and recommendations contained here do not constitute any type of guarantee whatsoever.

BEM-VINDO

Neste guia encontrarás toda a informação para tirar o máximo partido do teu SPC Smartee Pop.

CRIE UMA CONTA SPC

Inúmeras vantagens grátis à distancia de um click.

Antes de continuar a ler esta guia, recomendamos-lhe que visite **www.spc-universe.com**, QUE CRIE UMA CONTA SPC E REGISTE O SEU PRODUTO.

Desta maneira entrará no universo SPC: um clube exclusivo para os nossos clientes com importantes descontos e promoções para melhorar e renovar o seu equipamento SPC.

Além disto, **com esta conta poderá aceder grátis a todos os serviços da SPC**, como apps para tablets e smartphones e ao nosso suporte técnico.

Isto é a SPC. Um universo em tecnologia.

CONTEÚDO DA CAIXA

- Smartee Pop
- Base de carregamento
- Cabo USB
- Guia do utilizador
- Folha da garantia

CARACTERÍSTICAS

- Notificações contatos, telefonemas, monitor de sono, hodômetro, cardiometro, calendário, meteo, aviso sedentário, lembrete, multi esporte, assistente de voz, câmera e música remote.
- Microfone e alto-falante.
- Aplicativo “Smartee” para Android e iOS

LOCALIZAÇÃO DOS CONTROLOS

PT

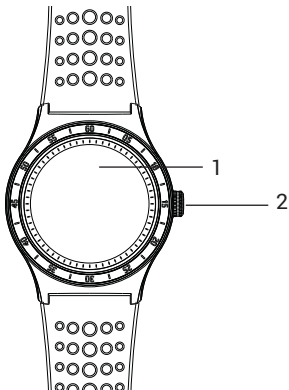

1. Pantalla

2. Botón encendido/apagado

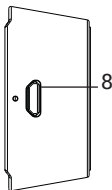
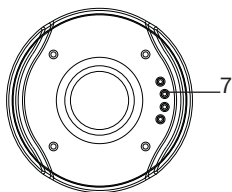
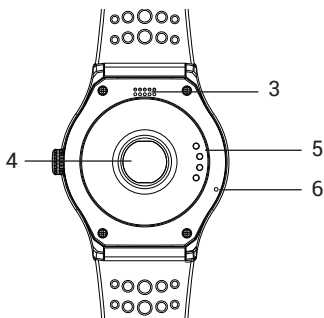

3. Altavoz

4. Pulsómetro

5. Pines de conexión

6. Micrófono

7. Pines de conexión

8. Entrada mini USB

UTILIZAÇÃO DE RELÓGIO

ACESO / DESLIGADO DO RELÓGIO

Para ligar o relógio, mantenha premido o botão de alimentação durante três segundos. Para desligar o relógio, proceda do mesmo modo.

PT

NAVEGANDO PELOS MENUS

Com a tela ativado, você pode navegar pelos vários menus usando os seguintes gestos: Toque na tela, vertical e horizontal deslizante



Com os gestos acima mencionados, você pode navegar entre os menus verticais e horizontais. A partir do menu principal, você pode navegar para os menus inferior e superior usando a roda do lado do relógio. Para confirmar esta escolha, pressionar o mesmo botão.



CARREGAMENTO DO DISPOSITIVO

Para carregar o relógio, coloque-o na base de carga com os polos de conexão em contato com o relógio na posição correta. Conecte uma extremidade do cabo USB à base de carga e a outra extremidade a um computador ou a uma fonte de alimentação.

PT

ECRÃ PRINCIPAL



A partir do ecrã principal poderá aceder através dos botões ou através do painel tátil a todos os menus disponíveis no seu dispositivo.

MENU VERTICAL

Deslizando de cima para baixo navegará pelo menu vertical superior.



Ajusta o nível de brilho do ecrã



Configura o relógio com/sem som, ou só vibração.



Desliga o Bluetooth e mostra perfis Bluetooth conectados



Enciende/Apaga el sensor de movimiento



Busca o dispositivo móvel vinculado ao Smartwatch

MODOS DO SMARTWATCH

O relógio possui vários modos ou perfis. Cada um com as seguintes características:

Ícone	Modo	Soar	Vibração	Bluetooth	GPS	Brilho
	Geral	Sim	Não	Sim	Não	Meios
	Reunião	Não	Sim	Sim	Não	Meios
	Avión	Sim	Não	No	Não	Meios
	Esporte	Sim	Não	Sim	Sim	Alto
	Economico	Não	Não	Não	Não	Baixo



Visualiza a informação meteorológica



Mostra o calendário

Deslizando de baixo para cima ou girando a roda até cima, navegará pelo menu vertical inferior. Poderá ver a sua atividade diária em diferentes ecrãs:



Mostra informação da sua atividade atual. Por defeito aparecerá "Caminhar"



Mostra informação do sono da última noite. A partir deste ecrã poderá visualizar esta informação em detalhe. Carregando sobre as três barras horizontais entrará na configuração do modo sono, podendo configurar hora de início e fim, e ativá-lo ou desativá-lo.

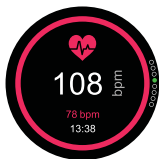

Mostra informação da sua pulsação na última medição realizada. Se deseja realizar outra medição de dados, carregue no centro do ecrã. Depois de alguns segundos, o relógio mostrará a pulsação atual.



Mostra os próximos lembretes. Poderá ativá-los e desativá-los. Estabelece os alarmes a partir da aplicação Smartee.

ATIVIDADE DIÁRIA

A partir do ecrã principal, deslizando no ecrã tátil de baixo para cima, ou girando a roda até cima, aparecerá um menu que se desdobra da seguinte forma:

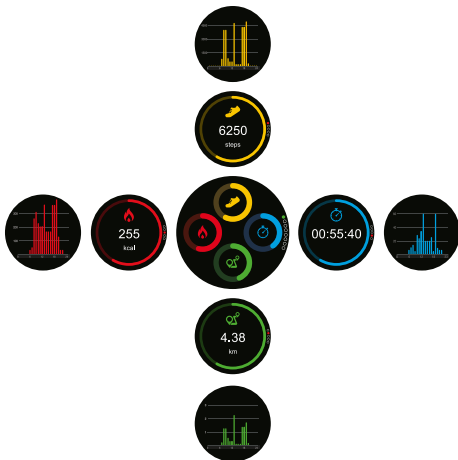

METAS DIARIAS

Estabelece diferentes metas para cada dado obtido pelo relógio. Para isso prima o botão editar. Serão listados todos os parâmetros que pode colocar numa meta.

PT

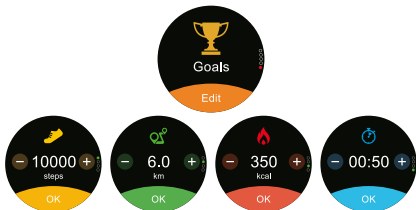

Pressionando nos símbolos +/- ajustará o algarismo, prima OK para estabelecer essa meta.

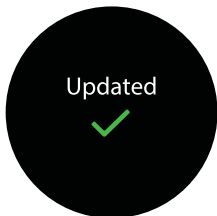

PRATICAR UM DESPORTO

Graças ao seu Smartee Pop, poderá parametrizar um desporto entre os 5 que traz por defeito o seu Smartwatch. A primeira coisa a fazer é seleccioná-lo. Para aceder à lista de desportos, prima o botão desporto. Acederá à lista de desportos a realizar:

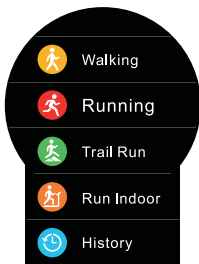

Caminhar



Correr



Percursos pedestre



Correr em tapete

Uma vez selecionado, poderá estabelecer metas para o desporto. Ajuste os parâmetros de distância, calorias, tempo total e ritmo (min/km)



PT

Durante a atividade, quando cumprir uma meta receberá um alerta no relógio.



Se não quer estabelecer uma meta, ative o modo livre:



Antes de iniciar o desporto, aceite ou rejeite o registo do ritmo cardíaco.

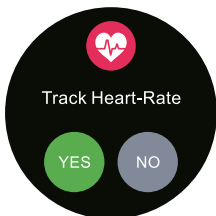

Durante a atividade, poderá consultar ao vivo os seguintes dados:

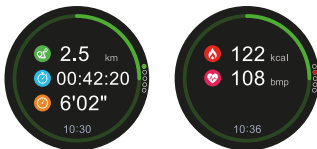

Em caso de ter o pulsímetro ativado poderá ver em que franja cardíaca está nesse momento

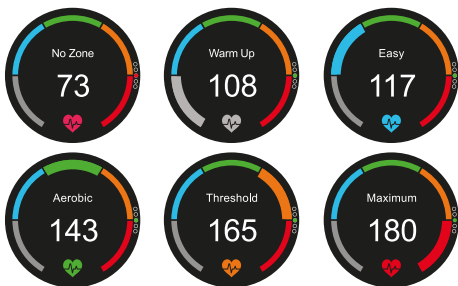

PT

No último ecrã, poderá terminar uma atividade ou pô-la em pausa para continuá-la mais tarde.



Uma vez finalizado o desporto, verá todos os parâmetros que o relógio capturou. Poderá escolher se quer guardar este desporto ou eliminá-lo do relógio.

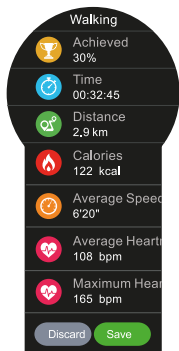

No caso de guardá-lo, poderá vê-lo mais tarde no seu Smartphone graças à aplicação Smartee e no relógio, na secção Historial, dentro da lista de desportos.

ACESSOS DIRETOS

No menu vertical do Smartphone, encontrará acessos rápidos a todas as restantes funções do relógio. Para poder utilizar algumas terá de ter o Smartwatch conectado ao seu Smartphone.

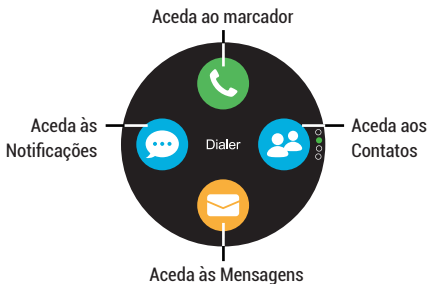

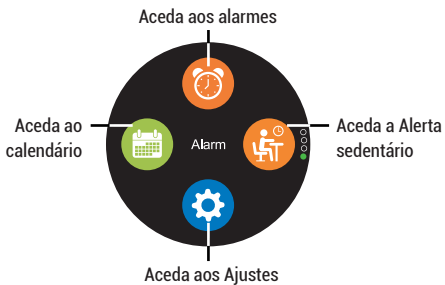

AJUSTES

No menu ajustes poderá configurar os seguintes parâmetros do seu relógio. Alguns destes parâmetros podem ser modificados a partir da aplicação Smartee:

- Perfil: ajusta dados do seu perfil.
- Bluetooth: Liga/Desliga a conexão Bluetooth.
- Monitor de sono: ajusta horas de início/fim do modo sono.
- Hora e data: ajusta o formato de hora e data.
- Unidade: escolhe em que medida aparecerão os dados no relógio.
- Movimento: Ativa/Desativa o sensor de movimento para o gesto do pulso.
- Efeito de som: ajusta parâmetros de som para os diferentes alertas.
- Visualizar: ajusta parâmetros do ecrã.
- Ver informação: mostra informação do seu dispositivo.

- Idioma: ajusta o idioma do dispositivo.
- Bateria: mostra a percentagem de carga da bateria.
- Restabelecer: restabelece o dispositivo de fábrica.

APP SMARTEE

Para descarregar a aplicação compatível com o seu SPC Smartee Pop, procure “Smartee” na PlayStore para Android e na AppStore para iOS.

No ecrã principal, se já tiver uma conta SPC poderá iniciar sessão. No caso de não ser ainda utilizador, poderá criar uma conta registando-se.

CONEXÃO COM ANDROID

De maneira automática, depois de iniciar sessão, o Smartee solicitará permissões ao Android para poder realizar todas as funções corretamente. Se deseja desfrutar de todas as funções do seu relógio, deverá aceitar todos.

Para conectar com Android o seu Smartwatch, em Smartee, ver Dispositivos. Terá que ter o Bluetooth do telefone e do Smartwatch ativados. Para fazer a vinculação existem três métodos: digitalizando o número de série, introduzi-lo

à mão ou procurá-lo na lista de dispositivos compatíveis, dentro da secção “Precisa de ajuda?”. O dispositivo deverá aparecer assim:

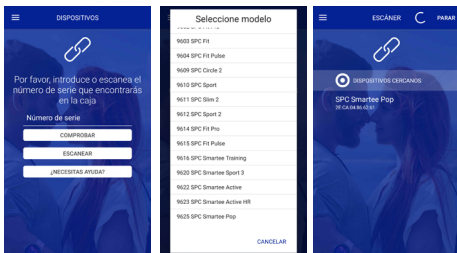

Dependendo da versão de Android e do modelo de telemóvel, pode ser preciso uma permissão adicional, como na imagem inferior.



Aceitando isto não deverão ocorrer problemas de conexão entre ambos os dispositivos.

Uma vez conectada, a secção dispositivos deverá apresentar-se assim:



Nesta secção poderá configurar parâmetros que, por sua vez, também se podem configurar a partir do próprio relógio.

Neste ecrã principal verá os dados de atividade do dia. Para atualizá-los deslize o dedo de cima para baixo.

PT



CONEXÃO EM iOS

Depois de iniciar sessão com a sua conta de SPC, poderá aceder à secção dispositivos para vincular o seu Smartwatch.

Para conectar com iOS o seu Smartwatch, em Smartee, ver Dispositivos. Terá que ter o Bluetooth do telefone e do Smartwatch ativados. Para a vinculação existem três métodos: digitalizando o número de série, introduzi-lo à mão ou procurar na lista de dispositivos compatíveis, dentro da secção “Precisa de ajuda?”. O dispositivo deverá aparecer assim:

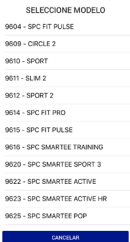

Em iOS, para poder desfrutar de todas as funções do seu Smartwatch, terá que se conectar a partir dos ajustes Bluetooth, o segundo perfil Bluetooth do seu Smartwatch.

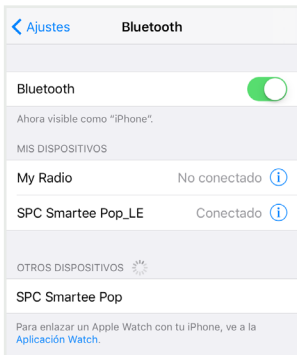
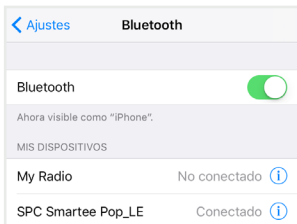



Com os dois perfis Bluetooth conectados, no seu Smartwatch aparecerá o ícone Bluetooth do seguinte modo: 

Funções como chamadas, contactos, busca de dispositivo, só estão disponíveis com os dois perfis Bluetooth conectados.

Para qualquer dúvida na secção suporte encontrará um guia de utilização da aplicação Smartee. Poderá ver os diferentes blocos que compõem a app e suas funções.

A informação que contém esta guia não poderá em nenhum caso ser transmitida, reproduzida ou difundida de forma alguma sem a autorização por escrito da SPC.

MARCAS COMERCIAIS

SPC é uma marca registada de **Smart Products Connection S.A.**

NOTA: A SPC reserva-se com o direito de modificar em qualquer momento a informação desta guia, a qual foi elaborada com maior cuidado, se bem que todas as informações e recomendações que aqui constam não constituem nenhuma garantia.

DECLARACIÓN DE CONFORMIDAD/DECLARATION OF
CONFORMITY/DECLARAÇÃO DE CONFORMIDADE
DECLARANTE/DECLARANT/DECLARANTE



Nombre/Name/Nome: **Smart Products Connection S.A.**
Domicilio/Address/Endereço: **Parque Tecnológico Álava
C/ Leonardo da Vinci, 14. (01510) Miñano (Álava)**
Tel: **(+34) 945 297 029** Fax: **(+34) 945 297 028**
CIF: **A-01042878**

EQUIPO/DEVICE/EQUIPAMENTO

Clase de equipo/Device type/Tipo de equipamento: **Smartwatch**
Fabricante/Manufacturer/Fabricante: **Smart Products Connection S.A.**
País Fabricación/Manufacturing country/País de fabricação: **China**
Marca/Brand/Marca: **SPC**
Denominación comercial/Commercial Name/Nome comercial: **9625A /
9625P**

NORMAS APLICADAS/APPLICABLE NORMS/NORMAS APLICÁVEIS

EN 60950-1: 2006 + A11: 2009 + A1: 2010 +A12: 2011 + A2: 2013
EN 62479: 2010
EN 301 48-1 V2.1.1 (2017-02)
EN 301 489-17 V3.1.1 (2017-02)
EN 300 328 V2.1.1 (2016-11)

FUNCIONALIDADES/FEATURES/CARACTERÍSTICAS

Características completas detalladas en el manual de usuario/Full features
detailed in the user manual/Características completas e em detalhe no
manual do usuário.

NÚMERO DE LOTE/ LOT NUMBER/NUMERO DE LOTE: 1708

Miñano, 10 de Julio de 2017

D. José María Acha-Orbea

Director General/General Manager/Diretor-geral

Esta declaración de conformidad está de acuerdo con la Directiva Europea 2014/53/
EU. This declaration of conformity is in compliance with the European Directive
2014/53/EU. Esta declaração de conformidade respeita as normas da Diretiva
Europeia 2014/53/EU.

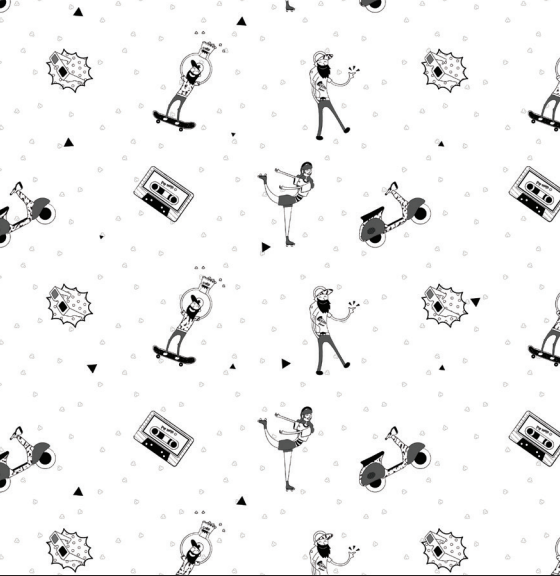

SPC_17/09/16

SPC 

spc-universe.com

